

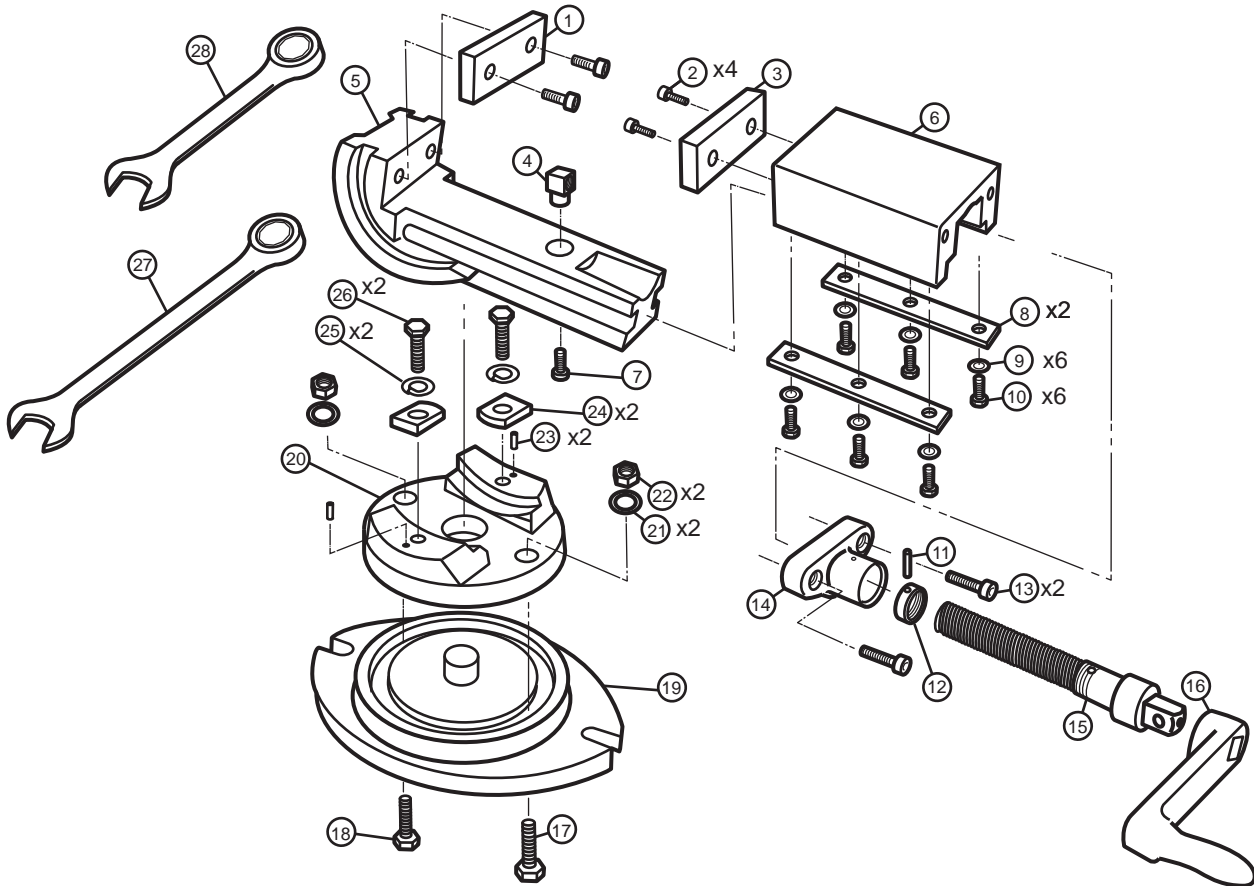

## Super Precision 2-Axis Angular Machine Vise Parts Diagram

3" Jaw Width, 3" Jaw Opening, 1-5/16" Jaw Depth

Stock #: 11704 Model #: AMV/SP-75



#	Part	Description	Qty
1	11704-01	Fixed Jaw Insert	1
2	11704-02	Socket Head Cap Screw	4
3	11704-03	Movable Jaw Insert	1
4	11704-04	Fixed Nut	1
5	11704-05	Vise Body	1
6	11704-06	Movable Jaw	1
7	11704-07	Screw	1
8	11704-08	Slide Plate	2
9	11704-09	Flat Washer	6
10	11704-10	Hex Cap Screw	6
11	11704-11	Roll Pin	1
12	11704-12	Collar	1
13	11704-13	Socket Head Cap Screw	2
14	11704-14	Sleeve	1

#	Part	Description	Qty
15	11704-15	Clamp Screw	1
16	11704-16	Handle	1
17	11704-17	Hex Cap Screw	1
18	11704-18	Hex Cap Screw	1
19	11704-19	Swivel Base	1
20	11704-20	Turret	1
21	11704-21	Flat Washer	2
22	11704-22	Hex Nut	2
23	11704-23	Pin	2
24	11704-24	Curved Washer	2
25	11704-25	Lock Washer	2
26	11704-26	Hex Cap Screw	2
27	11704-27	Combination Wrench	1
28	11704-28	Combination Wrench	1

**WARNING:** This product can expose you to chemicals including lead which is known to the State of California to cause cancer and birth defects or other reproductive harm. For more information go to <http://www.p65warnings.ca.gov>.

### WILTON

427 New Sanford Road  
 LaVergne, Tennessee 37086  
 Ph.: 800-274-6848  
[www.wiltontools.com](http://www.wiltontools.com)

**Part No. M-11704**

Edition 2 08/2018

Copyright © 2018 WILTON, a Division of JPW Industries, Inc.